

# LYDIA™ VOICE

THE GLOBAL #1 VOICE SOLUTION  
FOR ANDROID DEVICES



# EXPECT MORE FROM YOUR VOICE SOLUTION

**While the value proposition around applying voice technology for a warehouse worker has not really changed much over the last decade, the business environment, the shopping/buying experience, and technology options certainly have evolved and changed quite a bit.**

LYDIA™ Voice provides you with streamlined, best-in-class business processes to take your organization to the next level of operating efficiency. Our supply chain industry domain expertise has enabled us to successfully onboard hundreds of thousands of mobile workers around the world where we excel at multi-site customer implementations. LYDIA™ Voice is the leading native voice solution for SAP customers using EWM and WM. Direct integration is also available for more than 25 additional WMS solutions.

With its deep neural network technology, LYDIA™ Voice offers unparalleled voice recognition, the most important attribute of any voice solution, especially in the noisy industrial distribution center environment. LYDIA™ Voice does not require, or recommend outdated voice-template training, a remnant from the 1980's.

Our LYDIA™ Voice Co-Exist Solution enables companies to easily operate a two-vendor voice strategy, enabling earlier generation voice customers to easily transition to a modern LYDIA™ Voice solution without having to undertake any additional voice integration efforts. LYDIA™ Voice provides a completely integrated enterprise voice solution that includes a modern graphical Workflow Dialogue Designer integrated development environment (IDE). LYDIA™ Voice users are supported by a 24 x 7

staffed support center and has successfully scaled to more than 6,000 users on a single server instance.

LYDIA™ Voice provides the freedom to implement your solution how you want and on your preferred Android devices from suppliers such as Zebra and Samsung. We provide traditional on-premise licensing as well as SaaS and subscription options.

Delivering results starts with our Value Engagement Process. Our team will learn more about your specific business objectives as we gain an understanding of your detailed operational and workflow processes. We meet with key management to better understand the prioritization of the business issues that you want to address. Together, we will physically walk-through one of your targeted facilities to document and observe workers executing various tasks. Our observations and recommendations go well beyond just where voice technology could add quantifiable business value. Our aim is to help you run a smarter connected logistics operation.

**“Our LYDIA™ Voice solution adds to our overall profitability through improved productivity and greater picking accuracy. Overall, we’ve seen a 27% increase in productivity. We track errors in terms of one per thousand, and since using LYDIA™ Voice our errors have gone down.”**

**Vice President of Operations,  
Leading US Wholesaler**

## THE CORE VALUE PROPOSITION FOR LYDIA™ VOICE

- **Increased Productivity:** More tasks completed in less time for lower cost per transaction
- **Improved Accuracy:** Enhanced customer experience and reduced returns management costs
- **Increased Safety:** Workers are hands-free and eyes-free and now, headset-free with VoiceWear
- **Empowering Employees:** More confident workers are happier workers; reduces turnover
- **Faster New Employee Onboarding:** Reduced training time for full-time and temporary workers



# LYDIA™ VOICE EXCELS IN OPTIMIZING WORKFLOW PERFORMANCE

LYDIA™ Voice offers a range of voice-directed workflows that enable warehouse workers to increase their productivity. Customers enjoy maximum freedom of movement while being able to fully focus on essential process steps, leading to a significant increase in quality and processing efficiency. As a result, switching to a voice-enabled solution typically pays for itself within as little as a year. LYDIA™ Voice implementations typically start with the application being applied to the order picking area, where about 60% of the floor workforce traditionally exists.

Once implemented and the business gains greater confidence, LYDIA™ Voice use generally grows to touch other areas of the operation, as shown in the image below. A key advantage for LYDIA™ Voice is our ability to inexpensively and quickly add additional workflow use cases without the traditional high development costs, which has typically inhibited the growth and expansion of voice by previous generation solutions

## AREAS WHERE LYDIA™ VOICE EXCELS IN WORKFLOW PERFORMANCE

1. Goods receiving area
2. Returns management
3. Automated High Bay Storage/Retrieval
4. Cross dock
5. Put-to-Store
6. Put-Away
7. Replenishment
8. Back stocking
9. Order selection
10. Order selection – batch picking
11. Order selection – freezer
12. Line loading
13. Kitting with value added services
14. Bulk transfer
15. Packing and labeling stations
16. Management office
17. Truck loading
18. Yard management

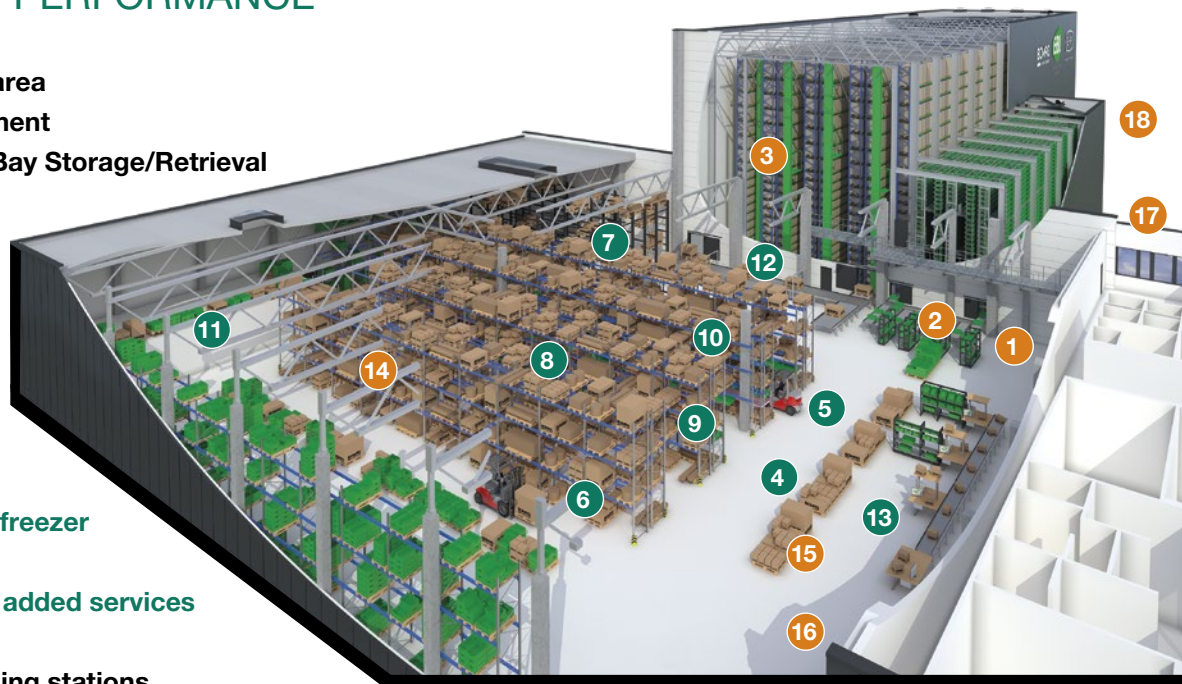

*Green text highlights areas where LYDIA™ Voice excels in workflow execution*

# KEY VOICE ENABLED WORKFLOW PROCESSES

**Case Picking:** The #1 use case for LYDIA™ Voice is case pick to pallet or to conveyor. Although voice picking typically eliminates the need for labels, LYDIA™ Voice also supports the use of labels, as typically required for the food service industry. LYDIA™ Voice also supports two-stage picking processes for slow-moving cases, sometimes referred to as planned inventory reserve (PIR) picking.

**Piece Picking:** The explosion of online order fulfillment has rapidly increased the use case for workflows that include piece picking to totes or cartons on carts, batch picking or on conveyors in a pick module. Variations include bucket-brigade pick and pass systems (zoneless picking), pick-and-put for high volume items, and two-stage picking for slow moving items.

**Pallet Picking:** Full pallet picking, for outbound shipping, can be interleaved with other full pallet moves (cross docking, replenishment, put-away) to reduce dead treading travel (when a lift truck is moving from one area to another with nothing on the forks).

**Put-Away:** LYDIA™ Voice-directed put-away can be used for full pallets, mixed pallets (multiple SKUs put-away in separate storage locations) or using carts with mixed SKUs. Barcode scanning is commonly incorporated in the voice-directed workflow when identifying / verifying items for put-away.

**Replenishment/Letdowns:** Replenishment can be implemented with LYDIA™ Voice for moving full pallets or mixed pallets from reserve or bulk storage to forward picking locations. In some instances, replenishment can be included in picking workflows or interleaved with other tasks.

**Put Wall/Sortation:** Warehouses that do not have automated sortation systems can use LYDIA™ Voice to assemble multi-line orders that have been picked in multiple zones or batches. Barcode scanning can be incorporated to identify/verify items. Items may be sorted to locations in a put wall.

**Cross Dock:** LYDIA™ Voice supports various types of cross dock processes including full transfers from receiving to shipping or moving and sorting to outbound staging destinations.



**Inventory Control/Cycle Count:** In some instances, cycle counting can be included in picking or other workflows, or it can be a separate task. LYDIA™ Voice supports opportunistic cycle counts (directing a picker to count a location after they pick from it).

**Truck Loading:** LYDIA™ Voice supports loading pallets for optimized route-stop delivery. The workflow process can also include user directed loading and may include safety and other inspection steps (HACCP) for example.

# LYDIA™ VOICE – DEEP NEURAL NETWORK VOICE RECOGNITION

The #1 reason why businesses prefer LYDIA™ Voice is due to its market leading voice recognition and the ability to successfully address the age-old problem of understanding difficult worker dialects. LYDIA™ Voice and its Deep Neural Network Acoustic Learning platform enables customers to benefit by providing market leading voice recognition capabilities. EPG joins industry leaders Amazon, Google, and Microsoft to offer solutions based on the next wave of AI, except that LYDIA™ Voice has been optimized for the noisy distribution center.

In the challenging industrial environment near-perfect voice recognition accuracy is required. The Lydia Voice

neural network solution outperforms the old-fashioned GMM technology by exceeding the confidence threshold of speech recognition. Since the early 2000s, Lydia Voice has not required any speech training. It is session-based self-adapting, as the data model continues to improve performance over time. Our neural network developed acoustic models address industrial environment sounds, such as: forklift beeps, pallet drops, fan/freezer noise and miscellaneous conversations, which helps enable unmatched voice recognition accuracy. The image below shows the worker benefits obtained with a modern deep neural network driven voice recognition solution.

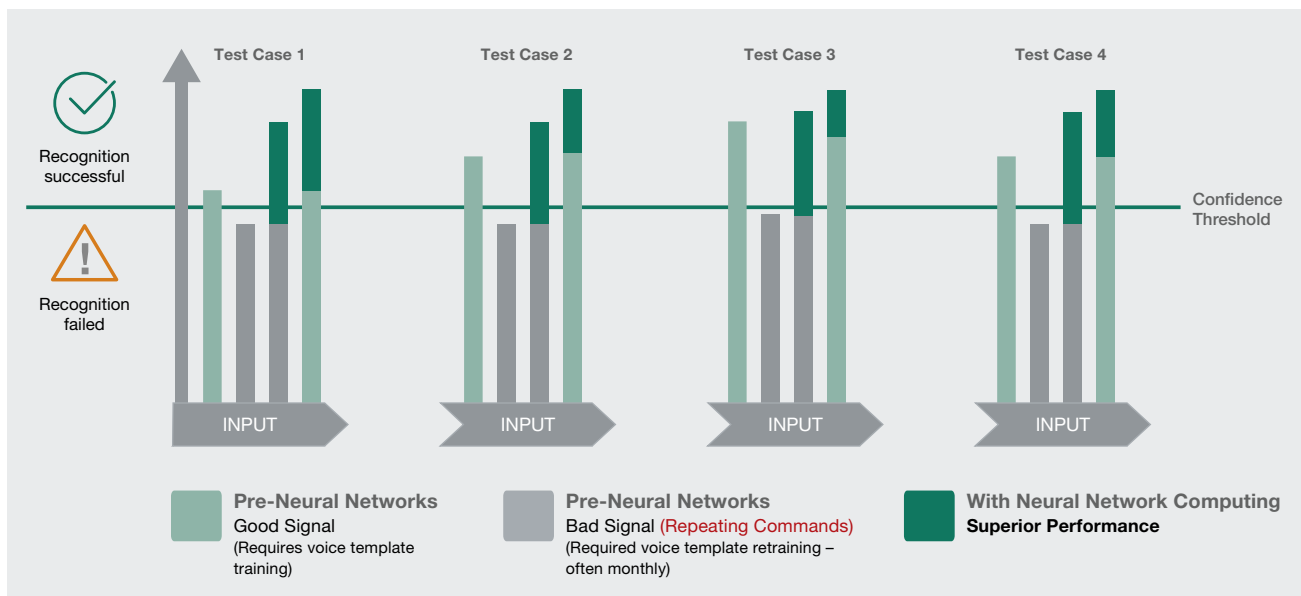

## NO VOICE TEMPLATE TRAINING REQUIRED

Our neural network helps provide extreme accuracy for those with challenging speech patterns and mixed dialects, without the requirement to train the associate with a set of in-vocabulary speech words, which often requires about a 30-minute training, as well as a monthly voice template retraining due to declining voice recognition performance. LYDIA™ Voice has consistently provided customers moving from handheld scanning solutions a 25% to 35% increase in productivity. In addition, customers moving to LYDIA™ Voice from a competitive voice solution have gained an additional 8% to 12% improvement in worker productivity. Our superior performance can quantitatively be attributed to the elimination of voice template training and ongoing retraining activities as well as less repeating and fewer missed recognized words and numbers.





## KEY VOICE ENABLED WORKFLOW PROCESSES

### LYDIA™ VOICE CO-PILOT

LYDIA™ Voice Co-Pilot is a market leading solution for initial training of new employees and first level on-site support. Using Co-Pilot, super users or managers can connect to any active voice client from a remote location and support the operator.

Most importantly, the manager/trainer is able to hear the worker in the managers desired language. Other voice training systems only let the trainer hear the worker in the language spoken by the worker. In mixed language environments this can cause on due strain on the training team who may not be familiar or comfortable enough to translate the voice dialogues to assist the worker.

The image on the right is an example view for the trainer who can listen to the worker voice dialogue, as well as understand key LYDIA™ Voice user settings to help optimize the worker experience and help the trainer provider feedback and recommendations to the worker. Customers who have made the jump to LYDIA™ Voice consistently report noticeable improvements in worker voice recognition and overall satisfaction – especially among those speaking Spanish and Afghan workers speaking Dari or Pashto.

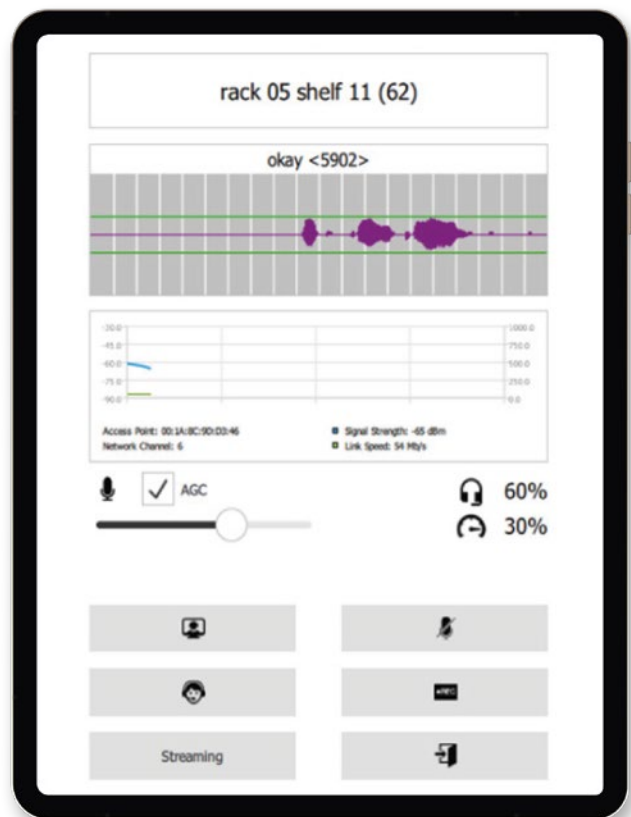



## COMPARING VOICE SOFTWARE FOR SPANISH SPEAKING WORKERS

One of the biggest surprises from customers who have transitioned to LYDIA™ Voice (and to us as well) is the significant difference in voice recognition performance for the Spanish speaking associate. We highlight the comparison because the quality of the modern LYDIA™ Voice neural network voice recognition has really become obvious to customers with Spanish speaking workers.

Customers who have transitioned to LYDIA™ Voice have specifically told us that they now are able to expand their labor pool recruiting options because they now can hire Spanish speakers across multiple dialects and those having extensive accent variations. Previously this has been a limiting factor and a little talked about productivity drag since these workers previously struggled even with voice template training efforts.



### LYDIA™ Voice Support 50+ Languages

Beyond Spanish and English LYDIA™ Voice now supports more than 50 languages in either a male or female voice. It is even possible to mix and match languages within applications.

# KEY VOICE ENABLED WORKFLOW PROCESSES

## **LYDIA™ Voice Supports a Wide Range of Android Devices**

LYDIA™ Voice runs on most Android mobile devices and forklift terminals. Over 50 devices from various manufacturers have already been tested for use with LYDIA™ Voice including Zebra and Samsung.

## **LYDIA™ Voice and Scanning**

LYDIA™ Voice seamlessly works with ring scanners for businesses that require/desire a scan confirmation or serial number/lot tracking as part of their standard operating procedures.

## **LYDIA™ Communicator**

LYDIA™ Communicator allows “calls” between your floor supervisors and workers. This integrated telephony function is a perfect tool for easy communication that greatly reduces or eliminates unnecessary delays or travel time, resulting in additional savings and worker efficiency.



## **No Expensive License Transfer Fees Required**

LYDIA™ Voice does not require an expensive software license transfer fee when you want to install an existing LYDIA™ Voice license to another device. This provides you with a lower TCO and further protects your investment if the business decides to later transition to any other device. This is vital as more companies move to newer Android devices.

## **Strong Data Security Standards**

LYDIA™ Voice supports the highest security data standards for WPA2 data security encryption standard for wireless networks including 802.11a, 802.11b, 802.11g and 802.11n and 802.11ac and secure data transmission via HTTPS.

## **Support for Web Services**

LYDIA™ Voice offers an open RESTful API to enable easy data integration and data access. REST is a logical choice for building APIs that allow users to connect and interact with cloud services because the calls are stateless.

## **LYDIA™ Voice VoiceWear – Hands-Free, Eyes-Free and Headset-Free**

Thanks to LYDIA™ Voice VoiceWear integrated speakers and microphone, workers no longer need a headset when using voice. This increased freedom of movement creates a distinct advantage for the worker.



# LYDIA™ VOICE DIALOGUE DESIGNER – INTEGRATED DEVELOPMENT ENVIRONMENT (IDE)

LYDIA™ Voice Dialogue Designer is our integrated development environment (IDE) software platform. Customers and certified partners can expand the capabilities of their LYDIA™ Voice solution using rapid application development (RAD) techniques. Dialogue Designer is an open, flexible and extensible modern IDE supporting the design, coding, testing, deployment and maintenance of customer-defined voice software solutions using standard Eclipse™ based XML tools. The IDE makes it easy to creatively add seamless integration with various data sources using RAD development and testing approaches.

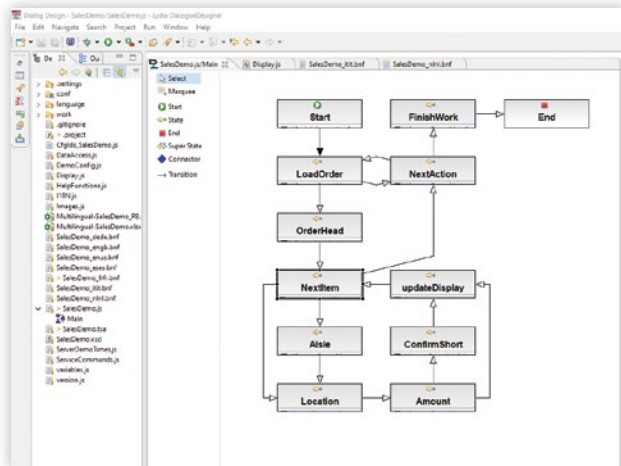

LYDIA™ Voice also provides a Microsoft .NET Assembly Library for businesses that prefer this development environment vs. Java. At EPG, it is important that customers have the freedom to support their own IT infrastructure strategy.

## HIGHLIGHTS INCLUDE:

- Stand-alone tool for the graphical design of the voice dialogue
- Syntax and error handling, syntax-check and autocompletion
- An interactive shell as a test environment
- A JavaScript or .Net Library LibPDL (Process Definition Language) for the development of voice workflow dialogue with LYDIA™ Voice
- Stand-alone tool for the graphical design of the voice dialogue
- Arithmetic computations for differences between picked and target amounts
- Avoids copy and paste or programming of redundant code
- A version management client
- A remote debugger
- Automatic generation of the grammar of the dialogue Configuration editor using XML standards
- Integrated help and tips
- Testing editor and validation of configuration and grammar
- Application testing before loading onto devices

# CLOUD ANALYTICS

For essential performance insights into how you can run your DC more effectively, LYDIA™ Voice offers advanced business analytics specifically designed for LYDIA™ Voice customers. Our solution uses data collection, aggregation and predictive modeling techniques for detailed and powerful data analysis – making sense of the vast amount of data available from a workflow environment. It's operational intelligence for a more efficient, more productive business. The following are examples of data that LYDIA™ Voice customers can obtain using our business intelligent (BI) tools.

## User Productivity

Sort how many picks a user completed overall by Company, Year, Month, Week and/or Date

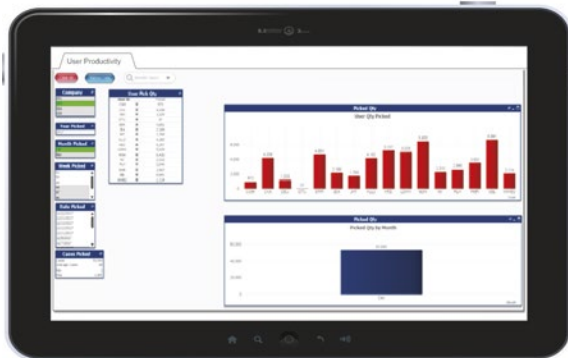

## Inventory Information

Review Inventory Put-Away by Available Quantity, FIFO or Best-Before Date



# INTELLIGENT OPTIMIZATION WITH LYDIA™ WAREHOUSE INTELLIGENCE (LWI)

Analyzing existing processes in order to optimize them is necessary to uncover potential improvements. The smart business intelligence tool **LYDIA™ Warehouse Intelligence (LWI)** continuously structures and analyzes various KPIs and makes them available for further evaluations in real-time.

LWI informs you about all irregularities. On the basis of the collected battery data, statements about the remaining battery life can also be derived. This allows you to react promptly and continuously optimize your processes to get the most out of your voice application.

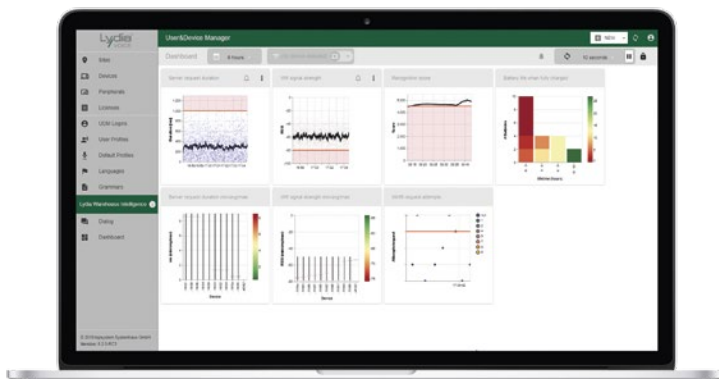

## LYDIA™ Warehouse Intelligence (LWI)

- Quality of the WIFI network
- Duration and number of requests between client and server
- Quality of speech recognition
- Dialogue logger for monitoring the dialogue confidence of your employees
- Runtime capacity and charging cycles of each individual battery

# LYDIA™ VOICE IS A NATIVE SOLUTION FOR SAP EWM AND WM

One of the biggest changes that has occurred to the voice market has been the growth of SAP and their successful EWM offering. The latest industry reports show SAP as the leading supplier of Supply Chain software solutions with almost 30% market share. This strong market position has helped break down barriers to voice adoption because EWM includes a seamless interface for voice solutions. While SAP may have made it easier to integrate voice solutions, most voice suppliers have not used this opportunity to leverage the architectural benefits SAP provides. Unfortunately for the SAP customer, most voice suppliers continue to either use a middleware solution or they have overly complicated the interface activities that require an SAP partner as well as voice partner. Neither option is desirable - businesses know managing a project with a single partner is hard enough, it becomes too complex when two partners have to be engaged. This is probably the main reason why other voice suppliers struggle to successfully penetrate the SAP market opportunity.

LYDIA™ Voice is 100% different than other voice suppliers because it provides a native interface to SAP. The LYDIA™ Voice Enterprise Connector for SAP allows native integration of LYDIA™ Voice solutions into SAP. Our entire application logic resides within SAP, enabling the customer to use all standard SAP functions and eliminates the need for a complex engagement process requiring two different partners. The advantage? You can carry out all adaptations and extensions to your LYDIA™ Voice application with your own SAP team.

The LYDIA™ Voice Enterprise Connector for SAP results in faster and more efficient data capture, a smoother workflow process and a significant increase in worker productivity. Warehouse operators receive their work instructions via voice on a mobile device enabling users to confirm, step by step, their work orders via speech. Quite simply, LYDIA™ Voice works like a microphone on SAP. The LYDIA™ Voice Enterprise Connector works seamlessly with barcode scanning, RFID scanning and manual keyboard entry. The LYDIA™ Voice Connector is the best solution for SAP customers wanting to add voice capabilities to their workflow processes in their SAP technology environment. For those who are operating in older SAP environments, we also offer a native interface using RFC Gateway.

*“We use the LYDIA™ Voice Suite for our customers in both returns management and picking. We were particularly impressed by the direct connection of the system to SAP, which we take over ourselves as a service provider for our customers. Since we support customers from a wide variety of industries in logistics, we need a flexible pick by voice system that can be tailored precisely to industry requirements.”*

**Expert Logistics Planner**

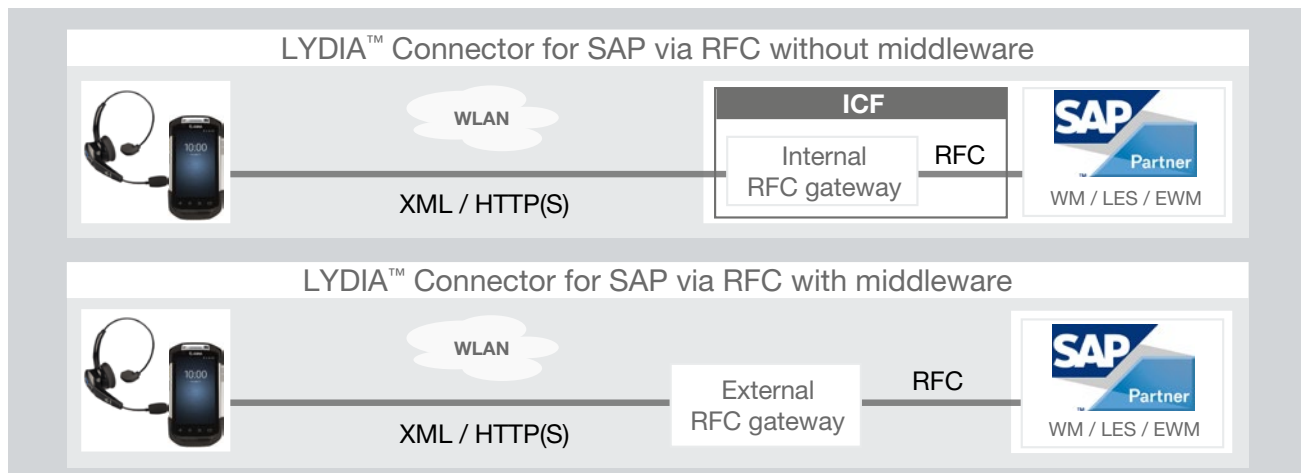



# INTEGRATE WITH LYDIA™ VOICE QUICKLY

While thousands of organizations are successfully using LYDIA™ Voice technology, recent Peerless Research about the voice market space asked some interesting questions which have helped to clarify many core reasons for not adopting voice technology. One of the questions asked was, “What do you envision as barriers to adopting voice technology?”

The study respondents were quite clear in that having to rely on IT resources to make changes to the existing WMS/ERP infrastructure was their number one issue. Upon further probing, Peerless Research confirmed that the lack of access to internal IT resources needed to support such a project was also a great limitation to widespread voice adoption

LYDIA™ Voice takes the pressure off your IT team. We offer the flexibility you need to fit within your IT architectural strategy, while reducing your project risk and meeting your desired go-live date. We offer the industry’s fastest integration with minimal IT time needed. Whether you desire a native voice interface (for SAP EWM and WM customers), a real-time direct interface (for Tier 1, Tier 2 and Tier 3 WMS solutions), or a near real-time interface (for in-house developed and older customized legacy solutions), LYDIA™ Voice offers you choices and multiple approaches. Another key point your IT team will note, integration with LYDIA™ Voice typically requires only days of effort vs. the traditional three to six-month project other voice providers require.

## LYDIA™ VOICE CO-EXIST SOLUTION

### Run LYDIA™ Voice and Vocollect Voice™ Together

LYDIA™ Voice Co-Exist is the ideal solution for Vocollect Voice customers who want to add LYDIA™ Voice along-side their existing voice deployment. The solution enables companies to easily operate a two-vendor voice strategy without having to undertake any additional voice integration efforts. The LYDIA™ Voice Co-Exist solution can be fully operational in a very short-time and requires minimal customer effort. The solution has been successfully operating at select larger Vocollect Voice customers for more than two years.

LYDIA™ Voice has consistently provided customers moving from handheld scanning solutions a 25% to 35% increase in productivity. In addition, customers moving to LYDIA™ Voice from a competitive voice solution have gained an additional 8% to 12% improvement in worker productivity. Our superior performance can quantitatively be attributed our voice recognition, the elimination of voice template training, workers having to repeat voice commands, and ongoing retraining activities.



## LYDIA™ VOICE ONE DAY PROVE IT PROJECT

The LYDIA™ Voice One Day Prove It Project is for businesses actively evaluating adding voice technology to their distribution center warehouse workflow processes. You won't find an easier or more affordable way to do so than our One Day Prove It Project, a one-day engagement that enables customers to validate LYDIA™ Voice's deep neural network voice recognition performance in their operating environment.

### EPG LYDIA™ Voice One Day Prove It Project Objectives



#### VALIDATE VOICE RECOGNITION PERFORMANCE

Within your operating environment



#### REDUCING ERROR RATES BY 50%\*

By focusing workers in a hands-free, eyes-free working environment.



#### INCREASING PRODUCTIVITY BY 20%

No voice-template training required or recommended

### EPG LYDIA™ Voice One Day Prove It Quantitative Outcomes

The final stage of the project is to present the outcomes of the comparisons between your current picking process and the potential outcomes you can expect if LYDIA™ Voice is implemented:

#### LYDIA™ Voice Metrics

- Number of Line Items Selected per Hour
- Review Current Solution Ease of Use
- Error Cost Analysis

#### LYDIA™ Voice Metrics

- Number of Line Items Selected per Hour
- Review LYDIA™ Voice Ease of Use
- Reduction of Errors Cost Analysis

During the Ease of Use Review, our team will highlight how LYDIA™ Voice provides cost savings, specifically around your current workforce, comparing how long it takes to train them on your current solution, if any additional training has to be repeated, how often, etc., and how quickly test workers were able to train and use LYDIA™ Voice. Overall, we are confident that LYDIA™ Voice will provide substantial cost savings to your business...let us Prove It!

\*Quantitative analysis of reduction of error rates projection only; qualified data to be provided from LYDIA™ Voice results gathered from a productive live environment.

# Download the LYDIA™ Voice Demo Today

You can download a demo of LYDIA™ Voice from either the Apple App store or the Google Play store. Search for LYDIA™ Voice. The fully functioning LYDIA™ Voice solution operates on Android and Windows devices.



## DOWNLOAD HERE:

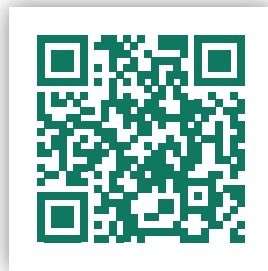

## COMPANY PROFILE

### EPG – Smarter Connected Logistics

Ehrhardt Partner Group (EPG) is the leading provider of comprehensive supply chain execution and LYDIA™ Voice software solutions for smarter connected logistics with more than 1,600 customers globally and almost 1,000 team members. EPG's highly configurable and scalable logistics solution, LFS, delivers Tier I functionality inclusive of: warehouse management, warehouse control and automation, resource management, transportation management, advanced business intelligence analytics and its industry leading iBrowser ensures ongoing support for all major browsers, delivering flexibility and platform independence. Our LYDIA™ Voice solution offers unparalleled voice recognition with its deep neural network technology and eliminates the need for voice template training, while interfacing with a multitude of WMS and ERP solutions, as well as real-time analytics available with TimeSquare Cloud Analytics.

To learn more, visit [www.epg.com](http://www.epg.com)



© 2024, EPS – Ehrhardt + Partner Solutions, Inc. All rights reserved.

Although the greatest care has been taken in the preparation and compilation of this brochure, Ehrhardt + Partner cannot be held for any liability or responsibility of any kind. All information, gathered from publicly available sources, is believed correct as of January 2022 and is for informational purposes only.

Apple Store is a registered trademark of Apple Inc.

Android is a trademark of and the Google Play Brand is the property of Google LLC.

Samsung is a trademark of Samsung Electronics Co., Ltd

SAP and other SAP products and services mentioned herein as well as their respective logos are trademarks or registered trademarks of SAP SE (or an SAP affiliate company) in Germany and other countries.

Vocollect voice, VoiceArtisan, VoiceDirect, TaskBuilder, Talkman, are trademarks or wholly owned entities of Honeywell International Inc.

Zebra is a trademark of Zebra Technologies Corporation.

All other trademarks are property of their respective owners.